

# **Introduction to Keylontic Morphogenetic Science: Keylontic Science for Daily Living**

An Introductory Workshop by

A'sha-yana Deane, Eckr MCEO

Author of

*Volume 1: Voyagers, the Sleeping Abductees*

And

*Volume 2: Voyagers, Secrets of Amenti*

The MCEO Freedom Teachings® Series

Presented by Adashi MCEO LLC in Association with Azurite Press MCEO Inc.

Copyright A'sha-yana & A'zah-yana Deane, 1999. All Rights Reserved

# Table Of Contents

NOTICE OF CLAIMS, CONSENT and COMMITMENT .....	3
Introduction .....	8
Topics of Discussion .....	9
I. Evolutionary Context: The Anatomy of Cosmic Structure .....	10
Chart 1: Cosmic Structure .....	11
II. Evolutionary Substance: Crystal Matrices - Morphogenetic Fields and Keylontic Science.....	12
Chart 2A: Crystal Matrices - Morphogenetic Fields and Keylontic Science.....	13
Chart 2B: Dimensions, Keylons and Fire Letters .....	14
Chart 2C: Fire Letters, Keylon Codes and Geomancies .....	15
III. Your Cosmic Connection: The Structure of Multi-dimensional Human Anatomy and Identity, the Crystal Body and the Silicate Matrix Crystal Gene.....	16
Chart 3A: The 8 Hova Bodies and Stations of Identity.....	17
Chart 3B: 15 Chakra & the 144 Fire Letters & 12 Geomancies of the Human Cellular Alphabet.....	18
Chart 3C: The 15 Chakras and 15 Levels of the Bio-energetic Field .....	19
Chart 3D: The Silicate Matrix Crystal Gene - DNA and the Morphogenetic Crystal Body.....	20
Chart 3E: The Interwoven Body-Mind-Spirit System .....	21
IV. Evolutionary Mechanics: The Science of Dimensional Ascension .....	22
Chart 4A: Higher Identity Embodiment: Morphogenetic Frequency Accretion.....	23
Chart 4B: The 6 Levels of Density Manifestation .....	24
Evolution from Carbon- to Silica-Based Biology to Pure Consciousness.....	24
Chart 4C: Preparing for Silicate Matrix Activation .....	25
Chart 4D: Activating the Silicate Matrix.....	26
V. Preparing the Body for Time Acceleration:.....	27
Raising the Body's Frequency-Holding Capacity .....	27
Chart 5A: Practical Guidelines for Raising Frequency-Holding Capacity .....	28
Chart 5B: The D-5 Archetype Identity.....	29
Chart 5C: Anchoring the D-5 Archetype .....	30
Conclusion .....	31
The Most Important Things We Can Do Now .....	33

# NOTICE OF CLAIMS, CONSENT and COMMITMENT

## *Pertaining to MCEO Teachings, Techniques and Technologies*

### Contents

- Theoretical Perspectives
- MCEO Meditations for Spiritual Exploration, Medical and Psychiatric Considerations
- Claim of Authenticity
- Terms, Conditions, Agreements and Implied Consent
- A Commitment to Quality and the MCEO Course-book Manuals

### Theoretical Perspectives

MCEO teachings presently exist on Earth as a growing body of detailed information pertaining to the spirituality and science of creation and the history and evolution of humanity. MCEO teachings offer unique perspectives, techniques and technologies of mind and spirit that have proven useful to many people in the exploration and expansion of personal consciousness. Information contained within MCEO teachings represents a cohesive paradigm of ideas, beliefs and perspectives reportedly translated from ancient texts, which together comprise an affirmative and inspirational “point of view” or “world view” regarding the tangible realities of spirituality, the mechanics of creation, the history of our universe and the potentialities of the human condition. Like many popular “New Age” and “Traditional” paradigms of spiritual, scientific and historical beliefs, many points of view presented within MCEO teachings extend beyond the framework of presently recognized spiritual/religious, scientific and historical “fact” that can be verified through common contemporary scientific procedures. *Thus, like many other popular belief paradigms, including ALL known “New Age” and “Traditional” spiritual/religious doctrines and many fields of contemporary scientific study, the perspectives presented within the MCEO teachings must, too, be presently categorized as theoretical in nature.*

The *verifiable actuality*, and thus the potential validity, of the presently theoretical spiritual, scientific and historical perspectives of MCEO teachings pertaining to the “**Ancient Science of the Shields**” (scalar-standing-wave templates of matter and consciousness), “**Merkaba Mechanics**” (interdimensional electromagnetic vortex mechanics), “**DNA Template Activations**” (frequency accretion within the scalar template behind manifest chemical DNA), “**Interdimensional Structure**”, “**15-Dimensional Anatomy**”, “**Bio-Spiritual Healing**” (support of biological healing and well being through holistic spiritual practice) and **Humanity’s Evolutionary Journey**, perspectives which are featured within the **MCEO Kathara Bio-Spiritual Healing Program, MCEO Maharata “Dance For” Programs** and related published works of the MCEO, cannot at this time be “proved or disproved”. Therefore, the MCEO Paradigm and its related teachings, techniques and technologies are offered to the public as a unique and inspirational view point, solely for the purpose of public investigation, consideration and theoretical exploration.

Though the presently theoretical categorization of MCEO teachings within the public sector is recognized, it should also be recognized that members of the Azurite Press, Trustees and the AP Regents Council, as well as authorized MCEO translators/authors and teachers and many individuals within the international community, have personally chosen to accept the validity of MCEO teachings as representing more than a theoretical perspective, instead acknowledging the MCEO Paradigm as a factual reality interpretation, and practical worldview, through which progressive expansion of personal consciousness and coherent spiritual awakening are fostered. Such decision as to the factual or theoretical categorization of the MCEO Paradigm, and the responsibilities inherent to this decision, are deeply private spiritual issues, and thus must be assigned to the faculties of personal discretion.

### **MCEO Meditations for Spiritual Exploration, Medical and Psychiatric Considerations**

As the MCEO Paradigm is built upon presently theoretical spiritual, scientific and historical perspectives, any and all techniques and technologies offered through the MCEO Paradigm must also be considered as presently theoretical in nature, and thus any and all techniques and technologies presented within MCEO teachings are ***not intended to diagnose, treat or cure any disease or illness, nor are they intended as substitution for professional medical or psychiatric advisory or treatment.*** Techniques and technologies provided within MCEO teachings are offered to the public solely as ***“Meditations for Spiritual Exploration”***, with the intention of assisting to serve the further evolution of human consciousness through providing exposure to an expanded range of perspectives and potentialities. **It is strongly recommended that individuals having a history of medical or psychiatric difficulties, or whom are presently under the care of medical or psychiatric professionals, seek professional advisory before using any MCEO Meditations for Spiritual Exploration techniques or technologies.**

Since introduction of *MCEO Meditations for Spiritual Exploration* techniques and technologies in 1999 many people have claimed to receive beneficial affects and effects in the development and expansion of personal consciousness and spiritual awakening through use of MCEO techniques and technologies. There have also been a lesser number of reports of individuals claiming to receive no affect, effect or benefit at all, but there have been ***no reports of individuals claiming adverse medical, psychiatric or psychological affects or effects*** in conjunction with use of MCEO techniques and technologies. As a reflection of commitment to responsibility in presentation, MCEO techniques and technologies are not presented for exploration in the public domain until they are first and/or simultaneously explored, utilized or practiced by authorized MCEO translators/authors/ teachers and members of the Azurite Press Board of Directors. Though validation of factual actuality pertaining to affects, effects or benefits of practicing MCEO Meditations for Spiritual Exploration techniques and technologies must, like the techniques and technologies themselves, for the present time remain within the realm of theoretical exploration, it can be reported that since 1999, findings pertaining to the practicality of utilizing MCEO techniques and technologies have consistently revealed that affects and effects of such practices are ***quite individualized, though predominantly positive***, in nature. Therefore, however, ***no claims, promises or guarantees as to the affects, effects or benefits an individual might expect to encounter through use of MCEO techniques and technologies can be offered at this time.*** Utilization of MCEO Meditations for Spiritual Exploration techniques and technologies presently remains within the category of ***experimental self-exploration***, through which absolute conclusions regarding generalities of mass affect, effect, benefit or detriment cannot yet be drawn. ***An individual’s involvement with MCEO teachings, techniques and technologies represents a choice of personal decision and discretion, and thus responsibility pertaining to affect and effect of practice that are inherent to this choice must also remain with the individual.***

## Claim of Authenticity

In offering MCEO teachings for public exploration, **neither the translators/authors, publishers, promoters or related individuals and organizations make any claims whatsoever as to the factuality of ideas or perspectives contained within the MCEO Paradigm.** Though the *MCEO teaching texts themselves* do on occasion claim that certain ideas and perspectives are of a factual nature, such claims represent points of view intrinsically contained within the ancient texts from which contemporary translations are drawn. The authorized translators/authors of contemporary MCEO teaching texts hold a binding commitment to ensure the clearest and most accurate translation of MCEO texts as possible under current evolutionary circumstances; a *commitment to clarity and accuracy of translation* that must include the allowance of contemporary translation of any *claims of factuality as they are contained within the MCEO texts of antiquity.* **Information represented as *factual knowledge* within the MCEO texts of antiquity, and their contemporary translations, is understood to represent “*potential or possible factuality, expressed as factuality within the ancient texts, but which presently resides within the domain of theory*” within the context of contemporary publication.**

The contemporary translators/authors of MCEO teachings *claim only* that the MCEO text translations contained within presently published works bearing their authorship represent an “as-accurate-as-possible” translation of MCEO text records believed to have been created in ancient times, which the contemporary translators/authors have had opportunity to review through *authentic personal experiences.* Translators/authors thus make claims only as to the *authenticity of their personal experiences* through which review of ancient MCEO text records occurred and as to the factuality that translation of the reviewed ancient MCEO texts into contemporary English language has been rendered by them as clearly and accurately as possible.

As the original MCEO texts of antiquity are not presently in the direct possession of authorized contemporary translators/authors, and thus contemporary translators/authors cannot at this time publicly display these artifacts in order to validate the reality of their continued existence and verify their inherent content, those who explore contemporary MCEO texts translations must understand that such works are presented as theoretical perspectives and possibilities, the validity of which one may choose to believe, or disbelieve, upon the merit of one’s personal discretion. ***If ideas, concepts or perspectives contained within the MCEO texts, their contemporary translations or related teaching materials bear any resemblance to ideas, concepts or perspectives contained within any other presently known spiritual/religious, scientific or historical paradigms or teaching systems, such resemblance is purely coincidental.*** However, the event of such coincidence arising may potentially suggest that both the MCEO Paradigm and paradigms to which it might bear resemblance **may have arisen from a common source in antiquity** that has yet to be discovered or scientifically verified, but which would upon discovery lend credence and clarity to such coincidence.

## Terms, Conditions, Agreements and Implied Consent

As contemporary MCEO text translators/authors can make no claims or promises as to the factuality of ideas and perspectives presented within MCEO teachings, they likewise **cannot offer any claims, promises or guarantees as to the affects or effects that may or may not arise through personal use of MCEO teachings or Meditations for Spiritual Exploration techniques and technologies.** The responsibility for

decision to engage involvement with MCEO teachings, techniques or technologies rests with each individual, and thus the responsibility for any affects or effects that may or may not occur in conjunction with use of MCEO teachings, techniques and technologies must also rest with the individual. The *Meditations for Spiritual Exploration* techniques and technologies provided within MCEO teachings represent translations from the ancient MCEO texts, and are provided to the public as an **option for personal spiritual exploration, investigation and experimentation, to be utilized at the *personal discretion* of the reader or workshop attendee.**

**As stated in numerous public forums and workshops since 1999, *in choosing to utilize MCEO teachings, techniques or technologies* it is understood that *in so doing* the individual accepts full responsibility for any and all conditions that may or may not occur in conjunction with such practice. It is further recognized that the individual, *through the act of utilizing* MCEO teachings, techniques or technologies, *thereby through this act agrees* to release Azurite Press, Trustees, the AP Regents Council, authorized Kathara Bio-Spiritual Healing Program teachers and facilitators (pertaining only to MCEO-sanctioned Kathara “no-touch” procedures), authorized MCEO translators/authors, teachers, promoters and any individuals and organizations thereto related, from any and all claims of liability or damages perceived or assumed to occur in conjunction with involvement in MCEO teachings, techniques or technologies. This statement of Terms and Conditions represents a written *Notice of Implied Agreement and Consent to Liability Release* in regard to involvement with MCEO teachings, techniques and technologies. This Notice of Implied Agreement and Consent of Liability Release represents a *reiteration in specific written format* of previously provided notice as to the *necessity of taking personal responsibility for any and all consequences arising from chosen involvement with the MCEO Paradigm*; notice which has been frequently provide verbally in public forum since 1999. It is recognized that the *Implied Agreement and Consent to Terms and Conditions of Liability Release* stated here within is accepted and enacted as such *upon the act of chosen involvement with and/or practice of MCEO teachings, techniques and technologies*. If one is uncomfortable or in disagreement with this stated *Notice of Implied Agreement and Consent to Terms and Conditions of Liability Release*, it is suggested and recommended that one choose at this time non-involvement with MCEO teachings, techniques and technologies, until a future time wherein such concerns have been assuaged.**

### **A Commitment to Quality and the MCEO Course-book Manuals**

The authorized MCEO translators/authors, members of the MCEO, Azurite Press, Trustees, Regents Council, teachers and promoters of the MCEO Paradigm extend their greatest efforts in making MCEO teachings available for public exploration in **the most responsible and respectful manner possible**, whilst striving to maintain the **highest standards of integrity in MCEO text translation and teaching**. Intrinsic to such responsibility in presentation, authorized MCEO translators/authors, members of Azurite Press, Trustees, Regents Council and authorized teachers and facilitators of MCEO programs are all individuals who personally believe in the factuality of the MCEO Paradigm and who actively participate, for personal spiritual reasons, in MCEO programs, including personal utilization of MCEO techniques and technologies. These individuals all share a **common commitment to achieving and maintaining integrity, quality and responsibility in public presentation of MCEO teachings**; this shared commitment arises from a commonly shared, individually held, reverence, respect, appreciation for, and belief in the validity of, the MCEO Paradigm, its inherent teachings of personal spiritual self-discovery and the limitless potentialities of human consciousness that this paradigm suggests.

On behalf of this commitment to quality, may it be understood that **MCEO Course-book Manuals**, as featured within the MCEO *Kathara Bio-spiritual Healing Program, MCEO Maharata “Dance For” Programs, MCEO Masters Templar Stewardship Initiative Program* and other MCEO teaching programs, **do not represent completed books**, but rather exist as **companion text briefings** that are created in conjunction with

**specific corresponding live workshop presentations** which are preserved via **audio/ video recordings** that are made available on the *Azurite Press Products List* as specific Program Sets. The Course-book Manuals that accompany some of these audio-video workshop programs **contain only the charts, graphs and most pertinent information pertaining to their corresponding audio-video program**, and **do not contain the many pages of dialogue and detailed explanation** that is incorporated verbally within the audio-video program. Thus MCEO Course-book manuals are not intended to be used alone, but are rather intended for use as an **additional educational aid in conjunction with their corresponding audio-video workshop program**.

As new MCEO workshop materials are often released and translated during live workshop presentations, the corresponding Course-book Manuals and their inherent graphs and charts often reflect the immediacy of the new information provided in that they are initially rendered **“in-the-rough”**, often with portions of text in hand-written form, not yet “perfected” for book publication with appropriate dialogue text detail, typesetting, computer graphics, pagination and indexing. As each new workshop since 1999 has introduced the next level of new, live MCEO data translations, there has been insufficient time to “move backward” and perfect the quality of production pertaining to MCEO Course-Book Manual texts from previous workshops. The information and new MCEO teachings contained within each workshop program always reflect the standards of integrity and quality inherent to the MCEO Paradigm, but often timely public release of new materials is achieved at the expense of quality in product production. **The Azurite Press staff apologizes for any inconvenience that such “data-in-the-rough” may cause; however, if workshop programs were withheld from Product List release until their audio/video recordings and corresponding Course-book Manuals were “perfected” in terms of product production, it would be several years before these materials were released for public review.** As new MCEO teachings are often time-sensitive in regard to the unfolding of planetary events, especially since 2000, it has been of greater priority during this time to expedite availability of the MCEO teachings contained within the products, than it has been to demonstrate the standards of excellence in quality product production that remains a goal of Azurite Press.

For the time being, MCEO audio-video-Course-book Programs are in a **state of continued evolution**, as the small staff at Azurite Press, with the assistance of numerous individuals who volunteer their time and talents, endeavor to compile dialogue transcripts and perfect typesetting, computer graphics and format organization of previous MCEO workshop presentations in effort to fulfill the goal of creating “perfected” book publications that contain, and “do justice to”, the vast body of quality teachings that have been presented during the 1999-2003 MCEO workshops. The commitment to achieving excellence in quality of production, as well as quality of information, that is held by members of Azurite Press staff arises from the personal desires of staff members to “honor the spirit of the teachings” which they have found personally valuable, as well as from a desire to provide the best possible quality of product and service in spiritual respect to the public. Until the goal of achieving “perfected” product production quality is actualized, Azurite Press staff hopes that the public will share in the recognition that it is the **quality, and inherent substance, of MCEO information, more so than the “package that it comes in”, which demonstrates the value of Azurite Press MCEO educational products.**

.....*Azurite Press Board of Directors*

## Introduction

***Keylontic Morphogenetic Science*** is the *Point of Union* between *Scientific* and *Spiritual* perspective, through which we can begin to understand the reality of our connection to the Divine and to comprehend the purposes for and processes of our personal evolution.

Keylontic Science provides the knowledge and tools we will need to prepare the body for Earth's 2000-2017 Time Acceleration and Time Continuum Shift.

***Keylonta:***  
**The Science of Light, Sound**  
**the Subconscious Symbol Codes and**  
**the Base Codes of Matter.**



## Topics of Discussion

- I. Evolutionary Context: *The Anatomy of Cosmic Structure.*
- II. Evolutionary Substance: *Crystal Matrices, Morphogenetic Fields and Keylontic Science.*
- III. Your Cosmic Connection: *The Structure of Multi-dimensional Human Anatomy and Identity, the Crystal Body and the Silicate Matrix Crystal Gene.*
- IV. Evolutionary Mechanics: *The Science of Dimensional Ascension.*
- V. Preparing the Body for Time Acceleration: *Beginning Keylonta techniques for Healing, Protection and Accelerating Biological and Spiritual Evolution.*

## ***I. Evolutionary Context: The Anatomy of Cosmic Structure***

- The 24 15-Dimensional Matrices.
- The 5 Harmonic Universes in each 15-Dimensional Matrix.
- The 3 dimensions and 6 Time Continua Cycles in each Harmonic Universe.
- The Time Matrix, the Energy Matrix and the Yunasai.
- Earth's present position within the 15-Dimensional arena.

## Chart 1: Cosmic Structure

1. The Time Matrix, the Energy Matrix and the Yunasai
2. 24 15-Dimensional Matrices

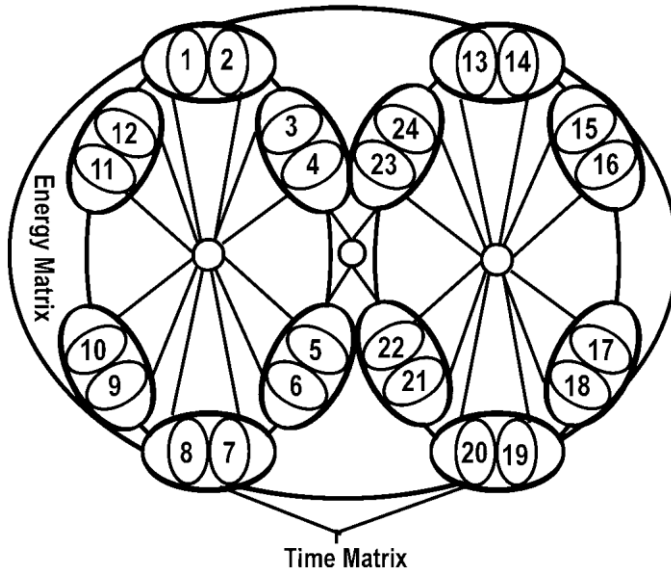

3. 5 Harmonic Universes per 15-Dimensional Matrix.

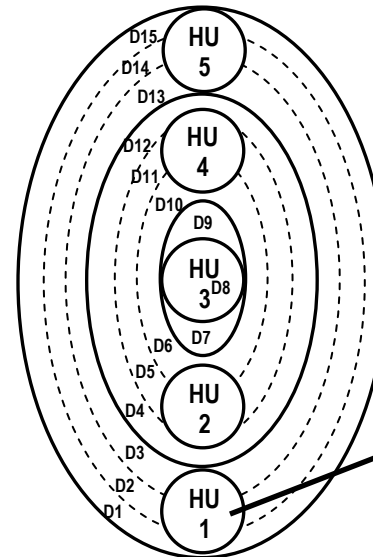

One 15-Dimensional Matrix with 5 Harmonic Universes

4. 3 dimensions and 6 Time Continua in each Harmonic Universe

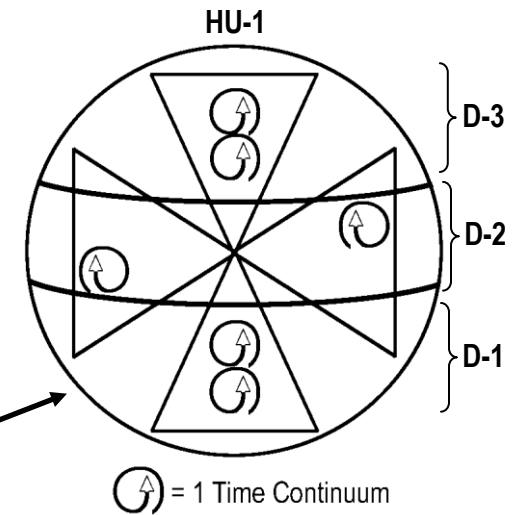

Earth is presently in Harmonic Universe-1 of its 15-Dimensional Matrix. Worlds of Harmonic Universes 2-5 and the Energy Matrix are considered as the **Higher Evolution**.

**Through understanding the Cosmic Crystal Matrices that we evolve within we can understand our personal path of evolution and our indelible connection to the Divine.**

## II. Evolutionary Substance: Crystal Matrices - Morphogenetic Fields and Keylontic Science

- *Crystal Matrix Morphogenetic Fields*: the Blueprints of manifestation.
- *Keylontic Science*; Morphogenetic Field mechanics. The Divine Science of Consciousness and Creation.
- The *Substance* of Morphogenetic Field Construction: Ultra-micro-particles *Partiki*, *Partika* and *Particum*.
- The *Form* of Morphogenetic Field Construction: *Partiki Grids*, *Keylons*, *Keylon Codes*, *Fire Letters* and *Geomancies*.

## Chart 2A: Crystal Matrices - Morphogenetic Fields and Keylontic Science

**1. Partiki, Partika and Particum:** Smallest units of energy-substance. Electro-tonal units of consciousness that are the building blocks of morphogenetic fields, matter and individuated conscious identity. Operate as minute, perpetual motion fission/fusion generators.

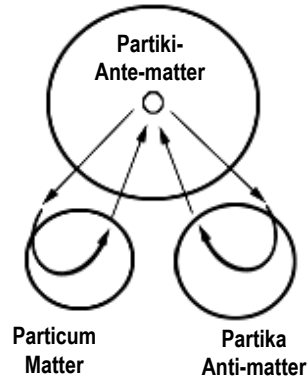

**2. Partiki Grids:** The fabric of morphogenetic field structure. Partiki units group to form interwoven Strands, then Grids of electro-tonal substance, out of which morphogenetic fields are fashioned. Out of a Unified Field of Partiki units, Partiki Grids form to create the frequency bands that make up dimensional fields and then to form individuated morphogenetic fields.

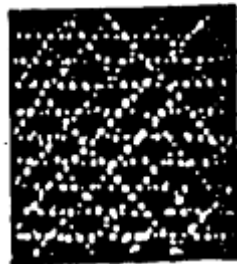

3. Partiki units continue to group or accrete upon the Partiki Grids, forming

**A. Keylons** – crystallizations of “frozen light” (standing scalar wave patterns and fixed points of tonal frequency), and

**B. Keylon Codes** – complex groupings of Keylons, which together form a crystalline template of light spectra, sound frequency and electro-magnetism that is the morphogenetic field Crystal Body – the Blueprint upon which matter and identity will manifest.

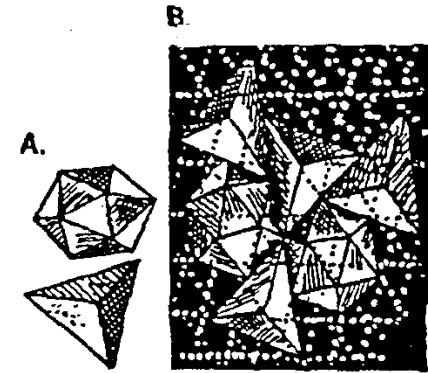

**4. Fire Letters:** Light-Symbol Codes that represent the electro-tonal programs of Keylons.

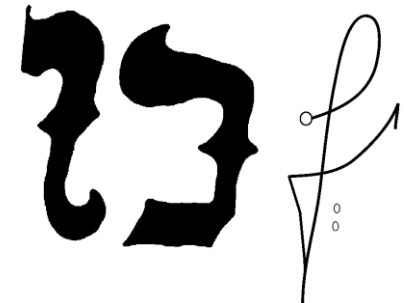

**5. Geomancies:** Composite Fire Letter Light-Symbol Control Codes that represent the electro-tonal programs of Keylon Codes, which are used to direct the Fire Letters/Keylons and the flow of energy through the morphogenetic field Crystal Body.

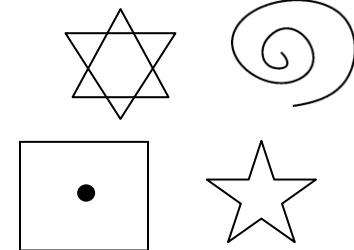

## Chart 2B: Dimensions, Keylons and Fire Letters

1. Dimensions represent **Scalar Fields** composed of specific patterns of electro-tonal frequency and light spectra. Partiki Units from the Universal Unified Field of Partiki/Energy form complex **Partiki Grids** which form the **Frequency Bands** and energetic fabric of which **Dimensional Fields** are composed. Dimensional Fields are Scalar Fields that exist in specific relationships to each other, which are grouped in *sets of three dimensions*, through which 3-dimensional reality fields take place. A group of 3 dimensions is called a **Harmonic Universe**.

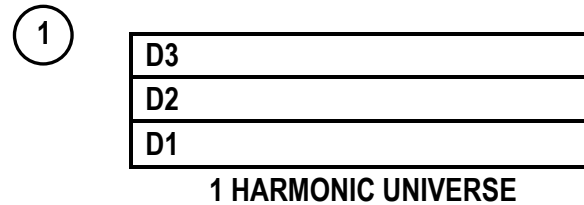

2. Each **Dimension** is composed of **12 Primary Sub-frequency Bands** that are formed by the **12 Primary Partiki Grid Lines**. Complex Partiki Grids build up upon the 12 Primary Sub-frequency Bands/ Partiki Grid Lines, forming the electro-magnetic fabric of light, sound and crystalline structure, upon which *dimensional morphogenetic fields* are built. Morphogenetic fields for individual forms will be constructed upon the Primary 36 Sub-frequency Bands (12 each x 3 dimensions) of the 3-dimensional system in which the forms will manifest.

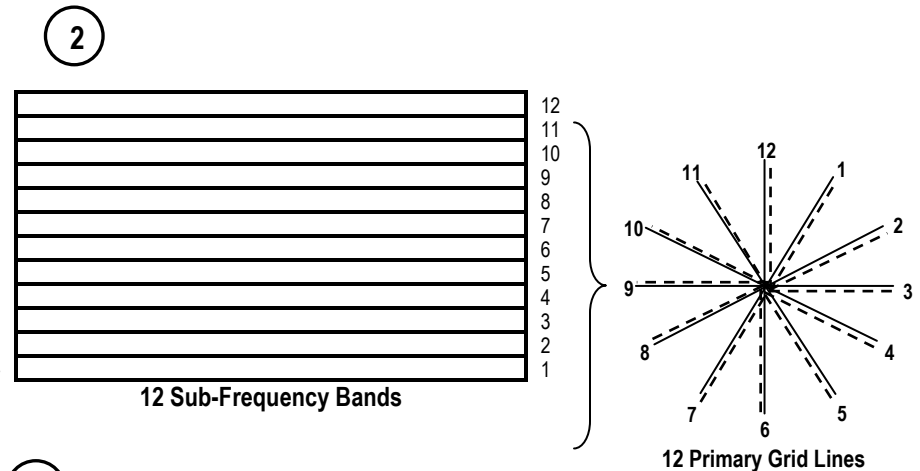

3. Each of the 12 Primary Sub-frequency Bands in 1 Dimension represents a fixed point of tonal frequency upon which the standing scalar wave pattern of **Keylon Crystals** are formed. Thus, each Dimension has **12 Primary Keylon forms** in its morphogenetic structure. The points of frequency / electro-tonal programs / standing scalar wave patterns that form the Keylons are called **Fire Letters**, thus each Dimension has **12 Primary Fire Letters** within its morphogenetic construction. Combinations of the characters of the original Hebrew Alphabet are used to depict the **180 Primary Fire Letters of a 15-Dimensional Matrix**. The alphabet letters represent *sound-tone combinations* which are the specific fixed points of tonal frequency within the dimensional fields. By using the appropriate **Fire Letter Sequences** the structure of matter, biology and consciousness can be directly affected as the Fire Letters govern the forms through which the Keylon Crystal mater blueprints will manifest.



## Chart 2C: Fire Letters, Keylon Codes and Geomancies

1. **Each 15-Dimensional Matrix has 180 Primary Fire Letters**, the electro-tonal programs that form Keylon Crystals. The **12 Primary Keylon Crystal/Fire Letters form within 1 dimensional morphogenetic field** and combine to form **Keylon Codes**, through which **Secondary and Tertiary Keylons and Fire Letters** are formed, creating a **crystalline morphogenetic template** for individuated form manifestation within the dimensional field. The **Fire Letters** represent the electro-tonal program/ fixed points of frequency/ standing scalar wave patterns, upon which **individual Keylon crystals** will form. The *composite* electro-tonal program/ fixed points of frequency/ standing scalar wave patterns upon which *complex Keylon Codes* are formed are called **Geomancies**. **Geomancies are the composite Light-symbol Codes that contain the entire Fire Letter content of 1 dimension, within a form's morphogenetic field.** Geomancies are considered the **Control Codes** within a dimensional field, as the Fire Letter sequences within a dimensional band can be controlled and directed through the Geomancies.

2. **Each Dimension has 12 Primary and numerous Secondary and Tertiary Fire Letters, upon which it is built, and 1 Primary Geomancy, that represents the entire electro-tonal program of that dimension.** Within the 15-Dimensional scale there are, thus, **15 Primary Geomancies** that control the formation of Keylons, Keylon Codes and the morphogenetic fields of forms, within the dimensionalized systems. The 15 Primary Geomancies control the form of the morphogenetic Crystal Body and the energy refraction pattern, through which energy will move through a form's morphogenetic field from the dimensional Unified Fields of Energy. Using the Geomancies, which appear as **geometrically formed light symbols**, the blueprints of matter and consciousness can be altered. **Geomancies control the Fire Letter sequences within the dimensional bands of the morphogenetic fields and, thus, they govern morphogenetic field construction and matter/ consciousness manifestation.** Geomancies represent patterns of light and sound that direct the mechanics of dimensional morphogenetic fields. **In Keylontic Science, we use the Geomancy Control Codes to re-align the human morphogenetic field with its original genetic imprint – the *Silicate Matrix*.**

Composite Fire Letters  
Of One Dimension =  
1 Geomancy Control Code  
Example of Geomancy:



1 Dimension = 12 Primary Fire  
Letters and 1 Geomancy.

### ***III. Your Cosmic Connection: The Structure of Multi-dimensional Human Anatomy and Identity, the Crystal Body and the Silicate Matrix Crystal Gene.***

- *Human Morphogenetic Field – Crystal Body Construction:* The 8 Hova Bodies and Identity Stations, the 15 Primary Chakras and Bio-energetic Field Levels, Humanity's 144 Primary Fire Letter Alphabet.
- *Body and Spirit – DNA and the Crystal Body:* The Silicate Matrix Crystal Gene – 12-strand DNA potential – our Divine Gift.
- *The Interwoven Body-Mind-Spirit System:* Correspondences between Identity Levels, Hova Bodies, Chakras, Bio-energetic Field, Fire Letters, Geomancies, Dimensions and DNA.



## Chart 3A: The 8 Hova Bodies and Stations of Identity

**The 8 Hova Bodies & Corresponding Identity Stations:** Hovas 1-5 are the *Ariea Bodies*, Hovas 6-8 are the *Yuseta Bodies*

The word *Hova* means a *Triadic Harmonic Light* (scalar wave) –

**Sound** (tonal frequency) **Grid** (morphogenetic Partiki grid).

1. **Nada Hova** – the Incarnate ID (Taurenic Body)  
(*Sub-conscious, Instinctual & Reasoning Minds*)
2. **Alphi Hova** – Soul Matrix ID (Doradic Body)  
(*Astral, Archetype & Angelic Minds*)
3. **Betcha Hova** – Oversoul Matrix ID (Metatronic Body)  
(*Ketheric, Monadic & Keriatic Minds*)
4. **Mahara Hova** – Avatar Matrix ID (Hydronic Body)  
(*Christiac, Buddhiac & Nirvanic Minds*)
5. **Raja Hova** – Rishi Matrix ID (Hedronic Body)  
(*Universal Conscious Mind*)
6. **Tanotra Hova** – Geomantic Entity Matrix ID (MerKaBah Body)  
(*Ascended Master Level – 1; Yunasai/God Mind-1*)
7. **Di-omni Hova** – RishA Matrix ID (SughmaDaTAA Body)  
(*Ascended Master Level-2; Yunasai/God Mind-2*)
8. **Prima Hova** – Eckar Matrix ID (Ecka-Ba Body)  
(*Ascended Master Level-3 – Yunasai/God At-one-ment*)

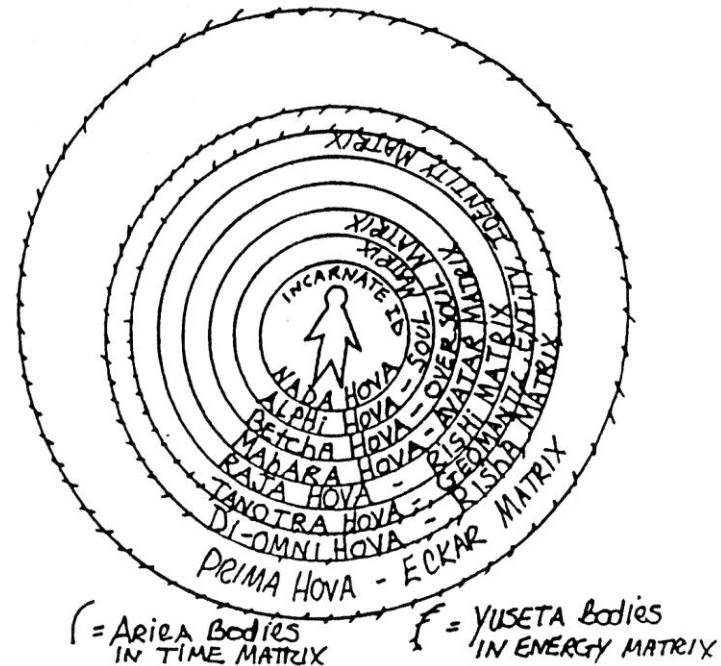

**Personal Spiritual evolution is the process of progressively expanding the personality to embody the higher stations of identity and the morphogenetic Crystal Body.** Through this process At-one-ment with our spiritual identity & God Consciousness is achieved. **Integration of the higher identity progressively changes the nature of the biological form, so biological & spiritual evolution are one.** Originally *identity integration* took place through one incarnational lifetime. Due to morphogenetic field distortions, the process now takes place through successive *reincarnations*. Reincarnation was not the natural evolutionary process of the original human lineage but it has been operational for over 5 million years. Through Keylontic Morphogenetic Science and the Silicate Matrix Crystal Gene, we can reclaim our eternal bodies and re-enter our natural state of evolution.

## Chart 3B: 15 Chakra & the 144 Fire Letters & 12 Geomancies of the Human Cellular Alphabet

- |   |  |
|---|--|
| 1. Base Chakra                          | 14. Universal MC-1 (32-36" above head) |
| 2. Sacral Chakra                        | 15. Universal MC-2 (deep space)        |
| 3. Solar Plexus Chakra                  |  |
| 4. Heart Chakra                         |  |
| 5. Throat-Thyroid Chakra                |  |
| 6. 3 <sup>rd</sup> Eye-Pituitary Chakra |  |
| 7. Crown-Pineal Chakra                  |  |
| Morphogenetic Chakras (MC)              |  |
| 8. Thymus-Cosmic Core (MC)              |  |
| 9. Thalamus-Galactic Core (MC)          |  |
| 10. Galactic MC-1 (6" above head)       |  |
| 11. Galactic MC-2 (18" above head)      |  |
| 12. Earth Star MC (6" below feet)       |  |
| 13. Earth Core MC (in Earth Core)       |  |

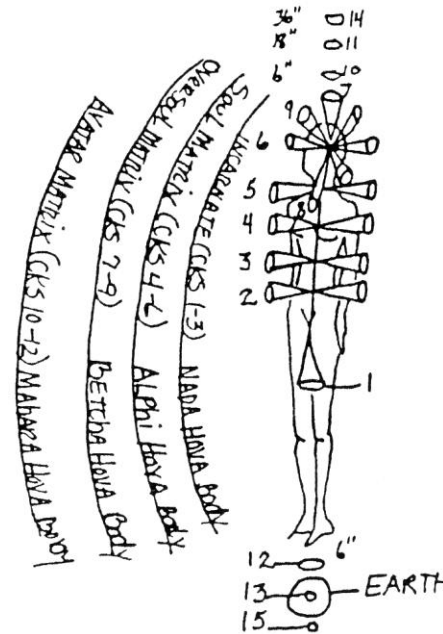

In human morphogenetic Crystal Body structure there are 15 Primary Chakra Centers (or Vortices), through which energy from the Universal Morphogenetic Field flows through and sustains the physical body and identity stations. The human biological form can embody the first 4 Ariea-Hova Bodies, which encompass 12 dimensions of the Crystal Body and the Avatar station of consciousness. The 12 dimensional frequency bands that can manifest in human biology each have 12 Primary Fire Letter/ Keylon forms, thus human biology has a Cellular Alphabet of 144 Primary Fire Letters (12 dimensions x 12 Fire Letters). Each of the 12 sets of 12 Fire Letters form 1 composite electro-tonal program/ Keylon Code form, expressed as the Geomancy Control Code. In Keylontic Science we use the Geomancy Control Codes in conjunction with the Chakras to active the Silicate Matrix Crystal Gene, so we may correct the morphogenetic field and genetic distortions that have kept us trapped within cycles of birth and death, unable to fully participate within our natural cycles of higher evolution.

## Chart 3C: The 15 Chakras and 15 Levels of the Bio-energetic Field

### The Taurenic Body (the Incarnate)

1. Etheric Body: D-1/D-8, Chakras 1 and 8
2. The Emotional Body: D-2, Chakra 2
3. The Mental Body: D-3, Chakra 3

### The Doradic Body (Soul Matrix)

4. Astral Body: D-4, Chakra 4
5. Archetype Body: D-5, Chakra 5
6. Angelic Body: D-6, Chakra 6

### The Metatronic Body (Oversoul Matrix)

7. Ketheric Body: D-7, Chakra 7
8. Monadic Body: D-8, Chakra 8
9. Keriatic Body: D-9, Chakra 9

### The Hydronic Body (Avatar Matrix)

10. Christiac Body: D-10, Chakra 10
11. Buddhaic Body: D-11, Chakra 11
12. Nirvanic Body: D-12, Chakra 12

### The Hedronic Body (Rishi Matrix)

- 13, 14, & 15. Universal Body, Chakras 13-15

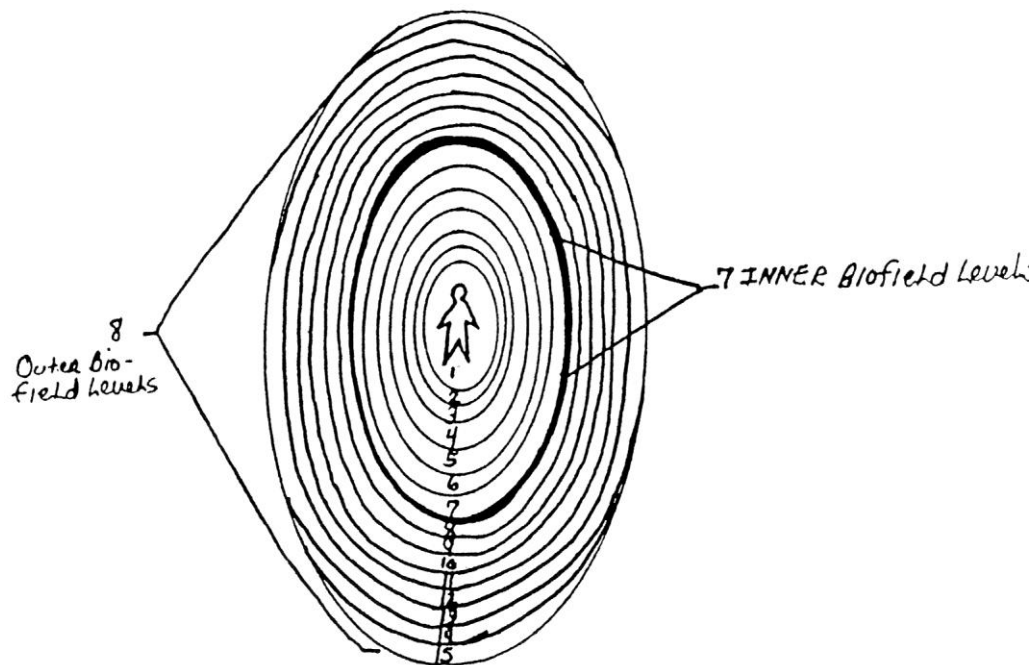

**The frequency bands of each of the 15 dimensions process through the Chakra and Bio-energetic Field Level with the corresponding number. The 5 Sections and 15 Levels of the Bio-energetic Field** connect the individual Morphogenetic Crystal Body within the Time Matrix to the 3 Levels of the Cosmic Energy Matrix, via the 15 Chakra System, creating an indelible crystalline conduit between the human, the Galaxies, the Universes, the Cosmos and the Central Source of Creation/God. **The 3 Levels of the Energy Matrix are:** 1. The **Triadic Level** (next level beyond the 15-Dimensional Matrices of the Time Matrix). 2. **The Polaric Level** and 3. The **Eckatic Level** (level nearest Source).

## Chart 3D: The Silicate Matrix Crystal Gene - DNA and the Morphogenetic Crystal Body

1. The Silicate Matrix gene code is a composite genetic configuration that manifests through the morphogenetic Crystal Body; it is the original genetic imprint for the human lineage. **The Silicate Matrix DNA code contains 12 double-helix DNA strands, existing in over-layer form,** which correspond to the 12 dimensions and 12 Fire Letter Sequences of the Human Crystal Body biological imprint.
2. **Each double-helix strand of the Silicate Matrix contains 12 Primary Base Codes** (Base Tones/ particle codes) **and 12 Primary Acceleration Codes** (Over Tones/ anti-particle codes), that together form **12 Primary Fire Letters** (fixed points of electro-tonal frequency/ standing scalar wave patterns) per 1 complete double-helix DNA strand. As each set of 12 Fire Letters combines to form 1 Geomancy Control Code, **each DNA strand has a corresponding Geomancy Code that governs the function and activation of that DNA strand.**
3. The Silicate Matrix also contains a set of **12 Fire Codes** – fixed points of frequency *between* DNA strands that allow strand helix to merge (particle and anti-particle fusion) and singular strands to fuse with each other, to create Cellular Transmutation.

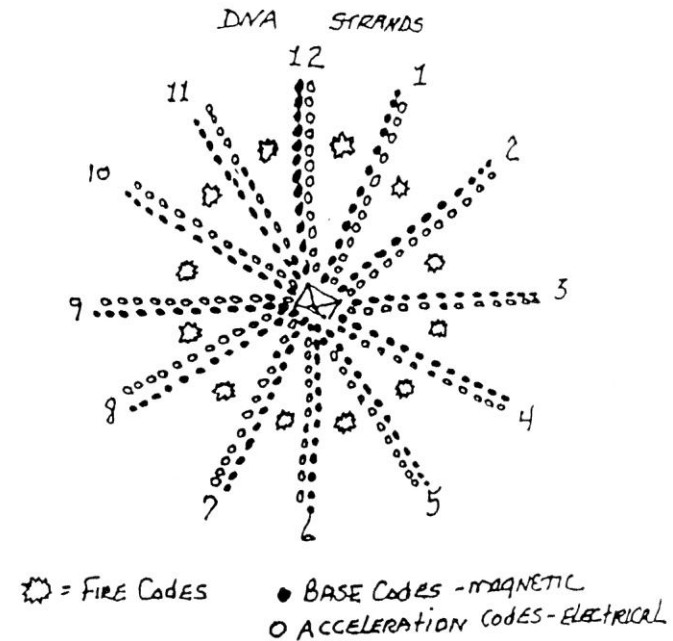

**Activation of the Silicate Matrix Crystal Gene allows for progressive biological transmutation out of solid matter and carbon-based biology, into Silica, Etheric and Pre-matter density, then into Ante-matter and the forms of pure, sentient, conscious radiation, characteristic to the higher levels of evolution.** The activation level of the DNA is called the **Accretion Level**. Most humans are presently at a 3-3.5 DNA Accretion Level. To adapt to the coming *Time Acceleration* and *Time Continuum Shift*, human DNA must reach a **4.5 strand Accretion Level**, which is achieved through using the Geomancy Control Codes and corresponding sound tones of Keylontic Science, through the Chakra system, to progressively realign and activate the Silicate Matrix Crystal Gene.

## Chart 3E: The Interwoven Body-Mind-Spirit System

1. The **12 DNA strands** of the Silicate Matrix correspond to the frequency bands of **12 of the 15 dimensions** within one 15-Dimensional Matrix.
2. The **5 Ariea-Hova Bodies** correspond to the **5 Harmonic Universes** of one 15-Dimensional Matrix within the Time Matrix. The **3 Yusetra-Hova Bodies** correspond to the **3 Levels of the Energy Matrix**. (Triadic Level = Tanotra Hova, Polaric Level = Di-omni Hova, Eckatic Level = Prima Hova).
3. 15 Chakras and 5 Sections and 15 Levels of the Bio-energetic Field: **5 Harmonic Universes = 5 Bio-energetic Field Sections = 5 Ariea-Hova Bodies = 5 sets of 3 dimensions and 5 sets of 3 Chakras**. 15 Dimensions = 15 Bio-energetic Field Levels = 15 Chakras.  
**Cosmic Identity Structure = 8 stations of Identity, 5 within the Time Matrix and 3 within the Energy Matrix.**

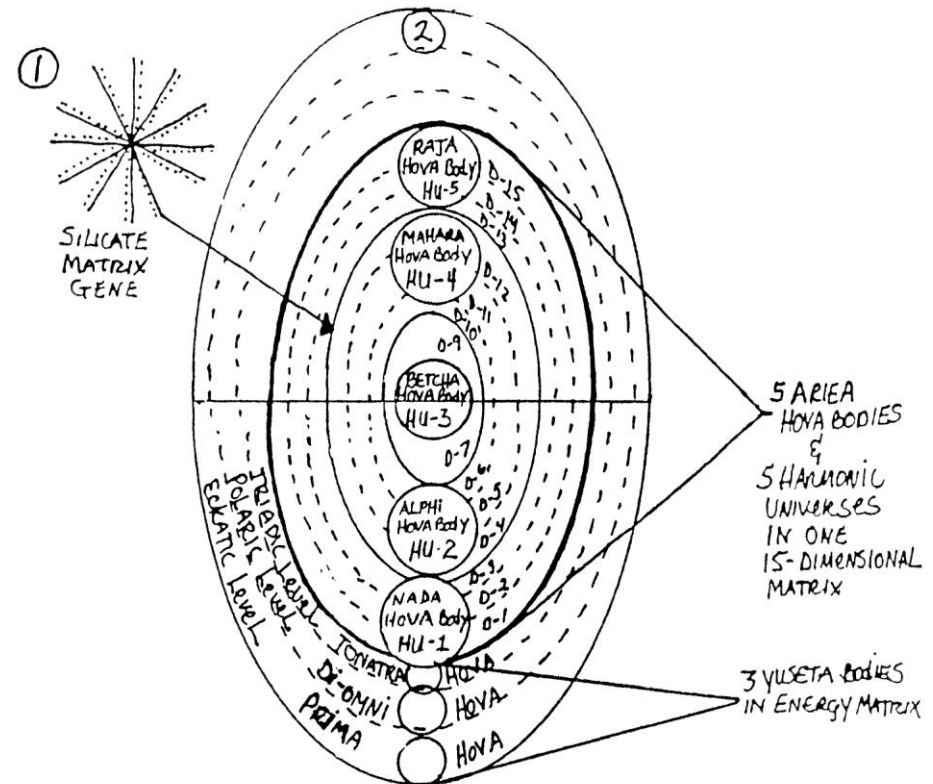

Through understanding the foundation structures upon which the body and consciousness are built we can learn to consciously direct the path of and accelerate our personal biological and spiritual evolution, rejoining the races of the Higher Evolution.

#### ***IV. Evolutionary Mechanics: The Science of Dimensional Ascension***

- *Higher Identity Embodiment: Morphogenetic Frequency Accretion.*
- *The 6 Levels of Density Manifestation: Dimensional Ascension and Cellular Transmutation from Carbon to Silica based biology to pure consciousness.*
- *Activating the Silicate Matrix: Keylontic Science, Setting the Grounding Field, Morphogenetic DNA Realignment, Imprinting and Programming, the Geomancies, Stellar Activations and Celestial Arieas.*

## Chart 4A: Higher Identity Embodiment: Morphogenetic Frequency Accretion

The **8 Hova Bodies**, which contain the **8 Stations of Identity**, are **Triadic (3 Tone) Harmonic Light (scalar wave) – Sound (fixed points of electro-tonal frequency) Grids** (morphogenetic Partiki grids) that represent specific patterns of light spectra and sound frequency. The process of Higher Identity/ Hova Body embodiment is thus the process of *bringing higher dimensional frequency bands into the personality and physical body*, and merging the lower and higher Hova Body grids; this process is called **Frequency Accretion**. As the higher identity stations/ Hova Bodies slowly but progressively embody (merge with the physically incarnate identity), the incarnate's morphogenetic **Crystal Body** progressively expands, bringing the **144 Fire Letters** (standing scalar waves/ fixed points of electro-tonal frequency) of the 12-strand **Silicate Matrix Crystal Gene** into activation within the operational gene code and bodily structure. Through the process of Frequency Accretion, the structural and metabolic processes of the body progressively change, creating **Dimensional Ascension** through **Cellular Transmutation**.

1. *Frequency bands of the Hova Body/ Identity Station above enter the Identity and Hova Body below, progressively expanding the morphogenetic field of the lower Hova Body/ Identity to encompass the Higher Hova Body and Identity. Evolution is Frequency Accretion.*

2. *Through Frequency Accretion of the Higher Hova Bodies and Identity Stations, the 12-strand DNA Silicate Matrix progressively activates, the conscious identity expands and the cellular form transmutes into less-dense states of mater.*

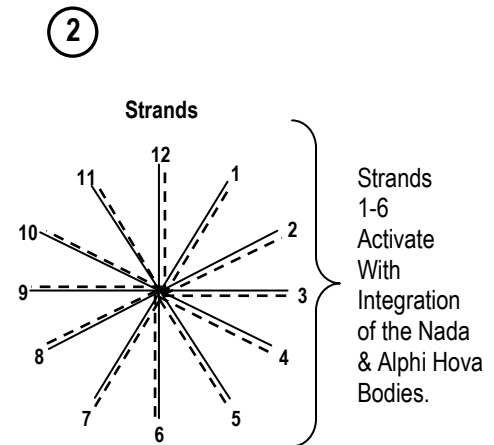
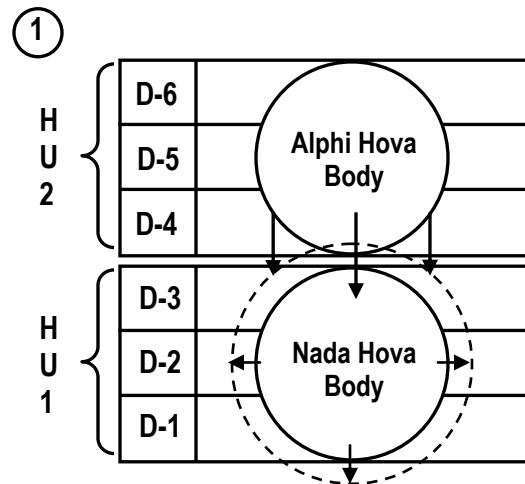

Human evolution is and has always been the process of **Dimensional Ascension** through **Frequency Accretion**. Through **Keylontic Morphogenetic Science** we can learn to guide and accelerate our evolutionary process from a conscious level, rather than allowing **genetic distortions** to control our evolutionary destiny. **Spiritual Evolution is the process of Higher Identity Embodiment**; physical evolution is the product of **Spiritual Evolution**, which creates progressive bodily transmutation.

## Chart 4B: The 6 Levels of Density Manifestation

### Evolution from Carbon to Silica Based Biology to Pure Consciousness

As the Silicate Matrix Crystal Gene activates and we evolve through Frequency Accretion, Dimensional Ascension and Cellular Transmutation, the physical substance of which our bodies are composed progressively changes form (via particle/ anti-particle fusion), from the dense matter particles of Harmonic Universe-1 through various stages of matter-density, until we re-emerge in wholeness within our original form of pure, sentient consciousness. Each Harmonic Universe within the 15-Dimensional Matrix has a level of matter density characteristic to its dimensional frequency bands. As we evolve upward in the dimensional scale, through the Time Continua of the higher Harmonic Universes, our body forms and consciousness take on the matter-density levels characteristic to the Harmonic Universes within which our conscious awareness is focused. **Time is simultaneous**, so our entire multi-dimensional identity exists at once; *our evolutionary process is that of re-merging the dimensionalized aspects of ourselves and awakening to our wholeness, through which we are freed from the holographic illusions of matter, space and time.*

#### Harmonic Universes (HU) and Matter Density Levels:

##### Terrestrial Races

1. HU-1/ D-1, 2, 3: **Physical matter density** *Carbon-based Biology*

##### Extra-terrestrial Races

2. HU-2/ D-4, 5, 6: **Physical-Etheric matter density** *Carbon-Silica-based Biology*

3. HU-3/ D-7, 8, 9: **Etheric matter density** *Crystalline-Silica-based Biology*

##### Meta-terrestrial Races

4. HU-4/ D-10, 11, 12: **Pre-matter density** *Crystalline-Liquid-Light-based form*

5. HU-5/ D-13, 14, 15: **Ante-matter density** *Crystalline-Light-Radiation-based form*

##### Ultra-terrestrial Races

6. **Energy Matrix** (3 levels) **non-matter density** *pure sentient consciousness*

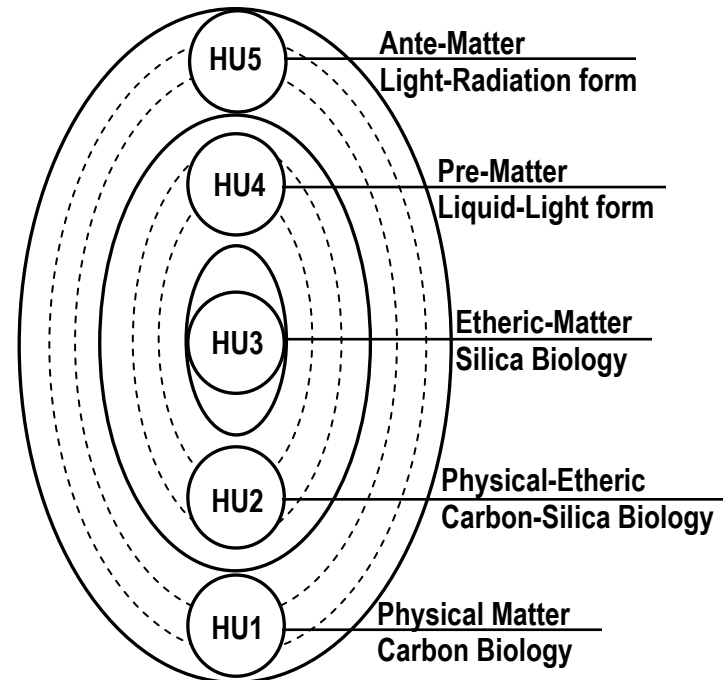

**Dimensional Ascension is our Return to Innocence – the wholeness of Identity and At-one-ment with Source that we knew before entering dimensional reality.**



## Chart 4C: Preparing for Silicate Matrix Activation

1. **Setting a Grounding Field:** Prior to accelerated activation of the Silicate Matrix Crystal Gene, the physical body must be prepared to receive the increase of higher dimensional sound, light and scalar wave spectra, that will accompany Silicate Matrix Activation.
  - A. Preparation of the body and mind involves **adjusting personal habitual behaviors** in a way that will allow your existing activated DNA strands to expand to their full capacity. The present **frequency** (electro-tonal content) of the body must be raised and the body's **oscillation** (particle pulsation rhythm) must be increased to the highest extent of its present boundaries (as set by the DNA), if the new wave spectra from the Silicate Matrix are to "ground" or stabilize within the body in a balanced way.
  - B. As one works to shift detrimental habit patterns, **Keylontic Exercises** for **Imprinting the 5<sup>th</sup> Dimensional Template – Archetype Identity** – into the morphogenetic field of the physical body will make shifting habit patterns easier, provide benefits in healing and protection and will begin the process of **Morphogenetic Crystal Body Imprinting**, through which the higher DNA strands can "ground" or anchor their frequencies into the body, once Silicate Matrix activation begins.

*Keylontic techniques for raising the body's frequency and oscillation and for Imprinting/ Anchoring the D-5 Template/ Archetype Identity are offered in the Tangible Structure of the Soul workshop.*

2. **Realigning DNA distortions in the Crystal Body:** Before the Silicate Matrix can be successfully activated within the operational DNA and body, distortions within the **144 Primary Fire Letters** that form the base light-sound structures of the Crystal Body, must be cleared, realigning the 144 Fire Letters with the precise frequencies/ scalar waves of the Fire Letters within each dimensional band. Keylontic Science technique uses the **Geomancy Control Codes** (form), specific **color spectra** (light), corresponding **tones** (sound) and **breathing** (energy circulation) to first **Imprint**, then **Program** the Morphogenetic Crystal Body, in order to re-administer the correct Fire Letter Sequences into the blueprint for the DNA strands. Once realignment is achieved activation of the Silicate Matrix can begin.

**Geomancies + Color + Toning + Breath =  
Imprinting and Programming the Crystal Body and DNA.**

## Chart 4D: Activating the Silicate Matrix

**Activating the Silicate Matrix into the operational genetic code:** Once morphogenetic Fire Letter distortions have been realigned in the Crystal Body, the Geomancy Control Codes, direction of light and sound through the Chakras, using the breath and Toning of the **Celestial Arieas** are used to progressively activate the Silicate Matrix into the operational gene code, while simultaneously beginning the embodiment of the higher Identity stations. The **Celestial Arieas** are the *specific tonal translations of the Fire Letter content* in each DNA strand. Using the *Arieas* stimulates the dormant Fire Letters into activation within the DNA. The Celestial Arieas are collectively called the **Music of the Spheres**.

**Geomancies + Color + Breath + Celestial Arieas Tones =  
Activation of the Silicate Matrix.**

The **HU-2 Alphi Hova Body** and **Soul Matrix Identity** will be the first aspects of higher identity to physically embody, with progressive activation of the 4<sup>th</sup>, 5<sup>th</sup> and 6<sup>th</sup> DNA strands and Imprinting and Integration of the Archetypal Identity.

*The mechanics of **Morphogenetic Realignment and Silicate Matrix Activation** are offered in continued publications and the suggested starting point is the **Essential New Comers Techniques** – Product Code ENT/2CD/S and the **Kathara Bio-Spiritual Healing System Level-1** – Product Code KA1-M/2DVD/3CDT  
[www.azuritepress.com](http://www.azuritepress.com)*

***V. Preparing the Body for Time Acceleration:  
Raising the Body's Frequency-Holding Capacity***

- Practical Guidelines: Setting the Grounding Field, Diet/ Consumption, Exercise, Health, Meditation, Sleep, Spirituality
- Beginning Keylontic Technique: Imprinting/ Anchoring the D-5 Template – Archetype Identity for health, protection, accelerated Soul Matrix integration and preparation for Silicate Matrix Activation.

## Chart 5A: Practical Guidelines for Raising Frequency Holding Capacity

**Setting a Grounding Field:** The *Frequency* of the body is determined by the *amount of electro-tonal Partiki units* contained in the Crystal Body morphogenetic field, The frequency content of the Crystal Body determines the body's **Vibration** (light contracted) / **Oscillation** (light expanded) rate, or that rate of speed at which the body's 3-dimensional particles will *pulsate*. To prepare the body for Time Acceleration, Silicate Matrix activation, expedited spiritual evolution and the resulting infusion of higher dimensional wave patterns, the *Crystal Body must be expanded to its greatest frequency holding capacity*. The process of raising the body's frequency and oscillation rhythms constitutes *adding more units of Partiki* (ante-matter light-radiation particles) and *reducing the amount of Particum units* (slower pulsating particles that form dense matter). Changing the Partiki-Particum ratio is facilitated by adjusting consumption habits to include substances which themselves contain higher Partiki content (and life force energy) and reducing substances that are composed of more dense or distorted Particum patterns. Increasing bodily oscillation is also facilitated by increasing the amount of oxygen and water in the body's daily intake and appropriate physical and mental exercise, sleep and meditation habits will assist the body to hold greater quantities of higher frequency energy.

### A few Rudimentary Guidelines for Raising the Body's Frequency (electro-tonal content), Lowering Vibration and Raising Oscillation Rates (particle pulsation)

**Dietary Guidelines:** Reduce intake of red meats, fats, dairy, sugars, excessive starches, "night shades" and salts. Include more fresh "**live foods**", shifting toward a **vegan** diet, with emphasis upon foods containing greater amounts of chlorophyll, Vitamins B, E, C and plant calcium; pay attention to **mineral balances**. Emphasize **hydration** and **oxygenation** of the body. Eat **smaller meals** more frequently, reduce or avoid protein-starch meal combinations, chemically processed foods, caffeine, nicotine and inorganic substances. Learn to **sense the vibration/oscillation rate of foods**; choose those with the greatest oscillation levels and don't over-cook or over-process foods, which reduces their oscillation rates. **Less is more if quality is chosen over quantity**. Even small adjustments will assist the body in raising frequency. Fresh **juice cleansing** and **short fasting** are also recommended.

**Exercise:** Moderate amounts of daily gentle exercise that increases **joint flexibility** and **cardiovascular strength and endurance** will help the body eliminate toxins, oxygenate and re-energize. Slow and steady increase in physical fitness, **not "pain is gain"**. Aim for **agility** and **endurance** rather than muscular bulk and power force. Activities that combine conscious breathing with bodily exercise are optimum. Use **deep breathing exercises**.

**Health:** Turn toward **holistic health care**, especially new technologies working **with light, sound and subtle energies**. **Balance new health care with traditional resources while decreasing excessive dependence upon non-holistic therapies**. Focus on **prevention via habitual adjustment**. Learn to use the **D-5 Template-Archetype** to restore the body's natural health imprint in the Crystal Body. Adjust **sleep** habits to shorter periods more often and use **meditation**.

***Keylontic Science offers a myriad of health and healing applications. Morphogenetic Field mechanics will one day revolutionize our approach to health as 15-Dimensional Human Anatomy becomes the foundation for health practice. The physical body and "spiritual" Crystal Body are interwoven. True health requires balancing of the multi-dimensional system.***

## Chart 5B: The D-5 Archetype Identity

1. The HU-2 **Alphi Hova** body (Soul Matrix ID) holds the original electro-tonal template for the HU-1 **Nada Hova** body (Incarnate body and ID). Disease within the incarnate body results from misalignments between the electro-tonal programs of the Alphi Hova and Nada Hova bodies. Some of these misalignments are carried in the DNA and cannot be realigned without Crystal Body reprogramming, but many imbalances and dis-ease conditions in the physical body can be corrected by **Imprinting** the Nada Hova body with the corrected electro-tonal program of the Alphi Hova body via Imprinting.
  
2. Within the 12 dimensions of human *biological* morphogenetic structure certain dimensional bands direct the function of other dimensional bands. The Geomancies and Fire Letters of these **controlling dimensional bands** govern the operation of the Crystal Body morphogenetic field. **Each Hova body has a control center** – the portion of its grid that contains the frequencies of a *controlling dimensional band*. The Alphi Hova / Soul Matrix body control center is the 5<sup>th</sup> dimensional Partiki grid – the station of Identity corresponding to the D-5 grid is the **Archetype**. **The D-5 Archetype is the control center for the Soul Matrix and Alphi Hova body. The Control Center for the Nada Hova body is the 2<sup>nd</sup> dimensional Partiki grid – the station of Identity corresponding to the D-2 grid is the Instinctual-Emotional Mind.**

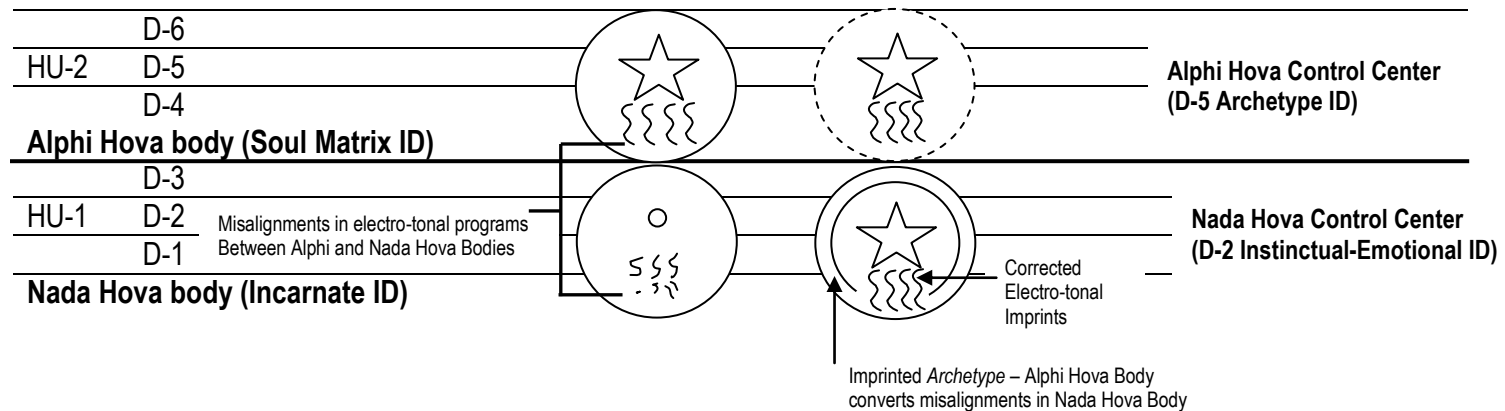

## Chart 5C: Anchoring the D-5 Archetype

To realign the incarnate physical body with its imprint for health and the personality with its soul purposes, **the D-5 Archetype of the Alphi Hova body** is used to **Imprint** the corrected electro-tonal pattern into the Nada Hova body of the incarnate. Once the Alphi Hova body is imprinted into the Nada Hova body, dormant codes in the DNA begin to activate and align with the corrected pattern, creating evolution toward health for the incarnate body and consciousness.

**Imprinting the D-5 Template is called Anchoring the Archetype.** It will not realign Fire letter distortions in the Crystal Body or mutations in the DNA *but will activate dormant Fire Letters and DNA codes that are not mutated.*

After Imprinting the Archetype, **Activation of the Archetype** (embodiment of the Alphi Hova body/ Soul Matrix) begins, through which Nada Hova body Fire Letter and DNA distortions are re-programmed using Keylontic Science and the 4<sup>th</sup>, 5<sup>th</sup> and 6<sup>th</sup> DNA strands are brought into activation.

**Imprinting the D-5 Template and Anchoring the Archetype are the first steps to begin creating an electro-tonal grid for bodily health, protection, DNA activation and spiritual evolution.**

**The Archetype of the Alphi Hova body is imprinted into the Nada Hova body by using the breath, the Chakra system, D-5 Geomancy Control Code and D-5 sound-light spectra.** During morphogenetic Imprinting or Programming, the **D-12 Geomancy Control Code** is also used for correct alignment with the Avatar ID and for protection.

**D-5 & D-12 Geomancy Control Code + D-5 Scalar Spectrum + D-5 Key Tone = Anchoring the Archetype**

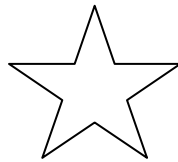

D-5 Geomancy

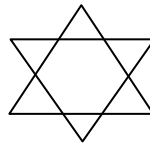

D-12 Geomancy

*Color Blue*

*Um-ă*

***Anchoring the Archetype creates a D-5 Frequency Seal around the Nada Hova body, providing protection from Keylontic Science and Electro-magnetic Pulse Technologies that Intruder ET Visitors are using to manipulate human populations. Embodiment of the Archetype creates immunity to Intruder tactics.***

# Conclusion

In this presentation we have been presented with a **Comprehensive Model of the Structure of Reality and Identity**, through which prior reality interpretations can be united within a greater picture of understanding.

We have learned of:

- **Cosmic Structure** – the context within which our evolution occurs and the hidden mechanics of evolution as being the process of Dimensional Ascension, through progressive **Cellular Transmutation**.
- **Morphogenetic Fields and the Sacred Science of Keylonta** – the crystalline blueprints behind matter and consciousness and the **Fire Letter** and **Geomancy** mechanics through which morphogenetic fields function.
- The **Anatomy of Multi-dimensional Identity** and the **Morphogenetic Crystal Body** – our personal, indelible connection to the Divine – the point of union between science and spirituality.
- We have discovered our hidden evolutionary potential to reclaim our immortality and re-enter the cycles of **Higher Evolution** through activation of the **Silicate Matrix Crystal Gene**.
- We have explored some beginning measures we can take to prepare our bodies for Time Acceleration and Continuum Shift, while simultaneously improving our health, creating personal protection and accelerating the process of our biological and spiritual evolution.

**Now we are faced with a choice as to whether we will embrace this new-yet-ancient Model of understanding as a tool for accelerated growth, or whether we will ignore this gift of knowledge because it is more encompassing than old familiar paradigms of belief.**

**The choice belongs to each of us.**

**Whether or not we choose to accept the Reality Model  
represented in Keylontic Science,  
Earth will face the challenges of Time Acceleration  
and a Time Continuum Shift between 2000-2017.**

Through Keylontic Science and the teachings of the Guardian Alliance we have the opportunity to prepare our bodies for the Time Shift, avert potentially detrimental conditions of Time Acceleration and to take an evolutionary leap forward toward our Destiny as a race – the knowledge of which has been hidden for eons within the **Secrets of Amenti**.

**Through these teachings, we are facilitated to reclaim our wholeness as pure Divine consciousness – and to begin “Our Return to Innocence”.**



# The Most Important Things We Can Do Now

To Prepare for 2000-2017

- **Begin preparing our bodies for the increase in Stellar electro-magnetic, light, sound and scalar waves that will accompany the planetary Time Acceleration by adjusting our habit patterns to assist the body in holding higher frequency.**
- Begin working with Keylontic Science to Anchor the D-5 Archetype into the body to create protection from Intruder manipulation and to prepare the body for activation of the Silicate Matrix Crystal Gene.
- **Begin working with the DNA through Keylontic Science to raise the DNA activation level from 3-3.5 accretion to 4.5 accretion level needed to accommodate Time Shift.**
- Trust that your Higher Stations of Identity will guide you through these times and work to open the lines of communication between you and your Soul Matrix identity, through meditation, spiritual development and learning to “Connect with your Higher Self”.
- **Have the courage to expand your present belief paradigms and learn about the challenges Earth will face between 2000-2017 so that you may learn what you need to know to prepare yourself for safe passage.**